

Блок управления БУД-430S(M)
 Схема электрическая принципиальная

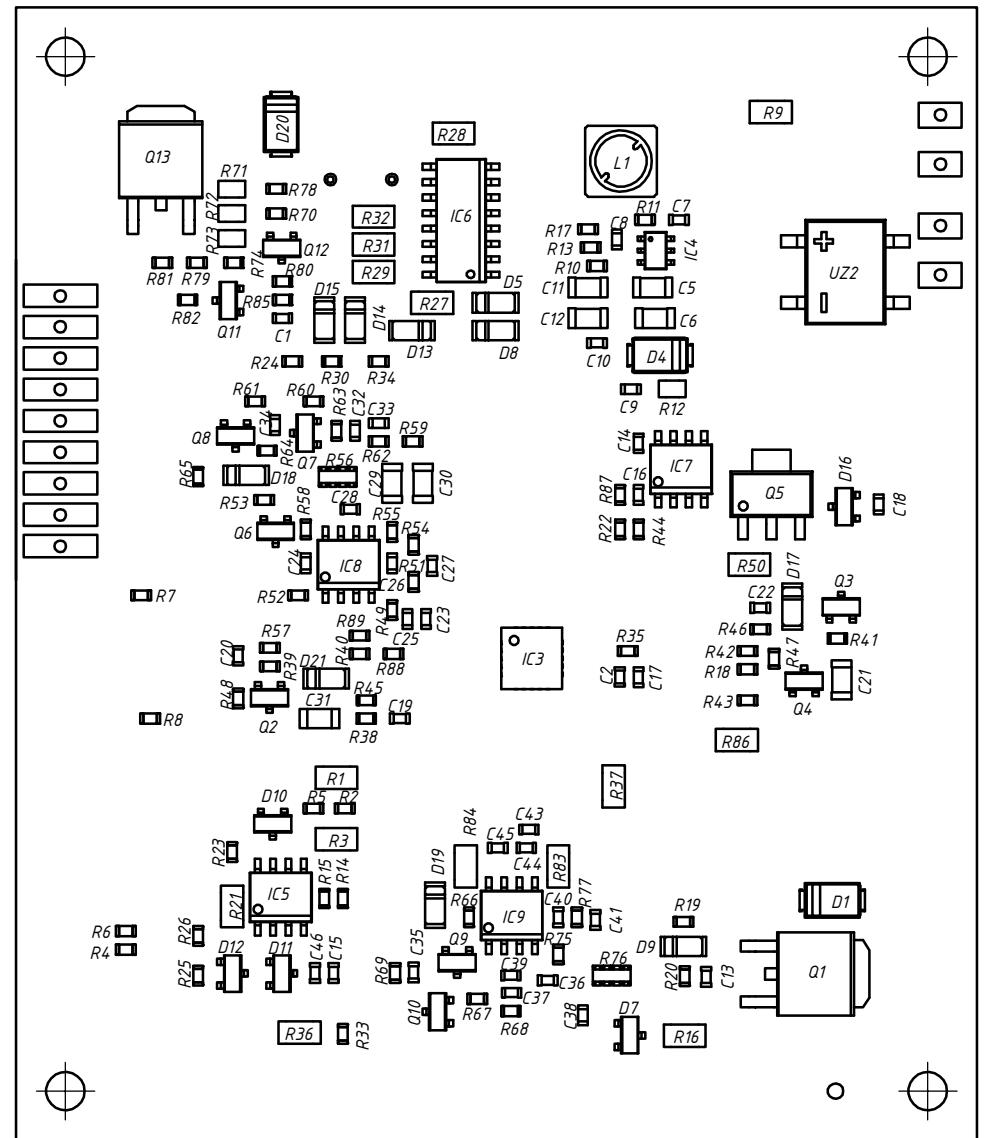

Плата БУД-430М
Сборочный чертеж

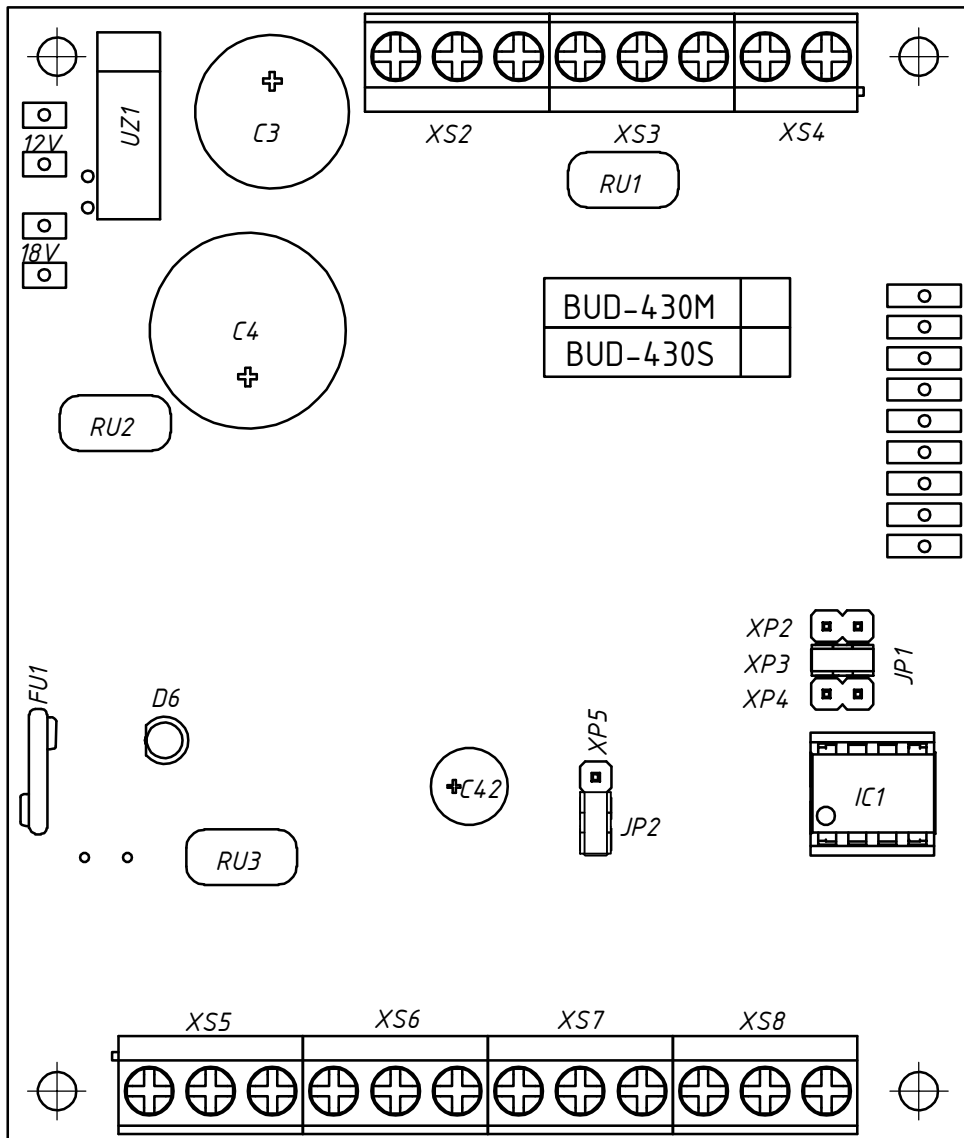
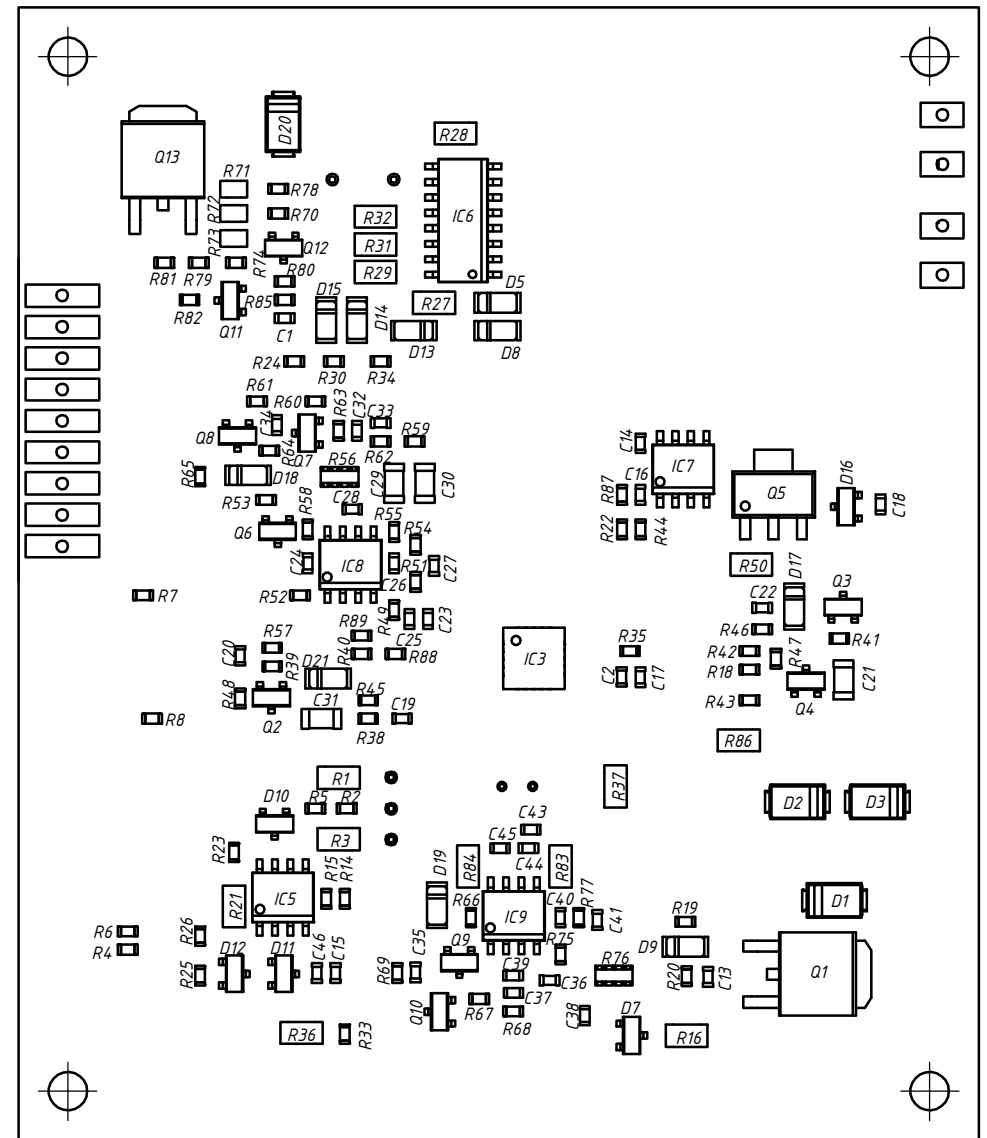
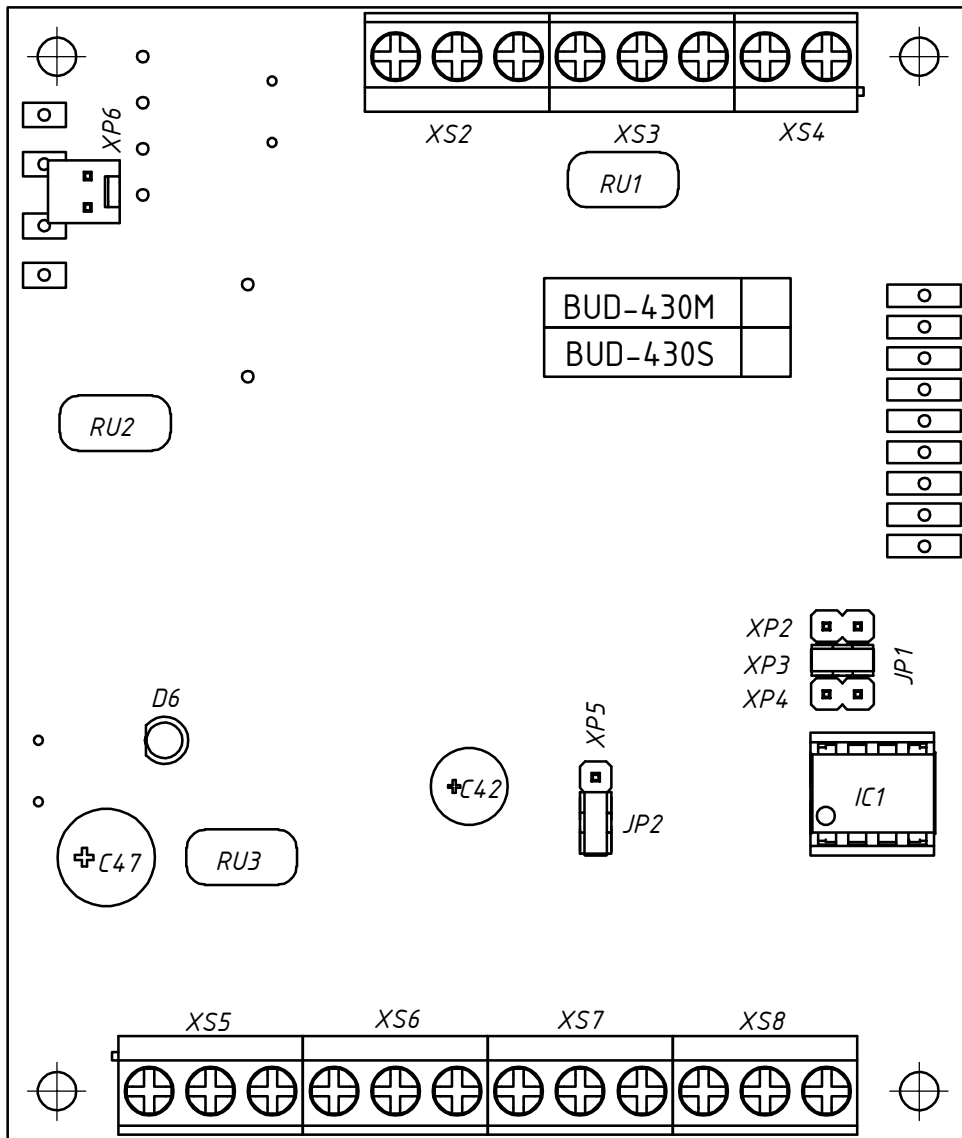

Плата БУД-430S
Сборочный чертеж

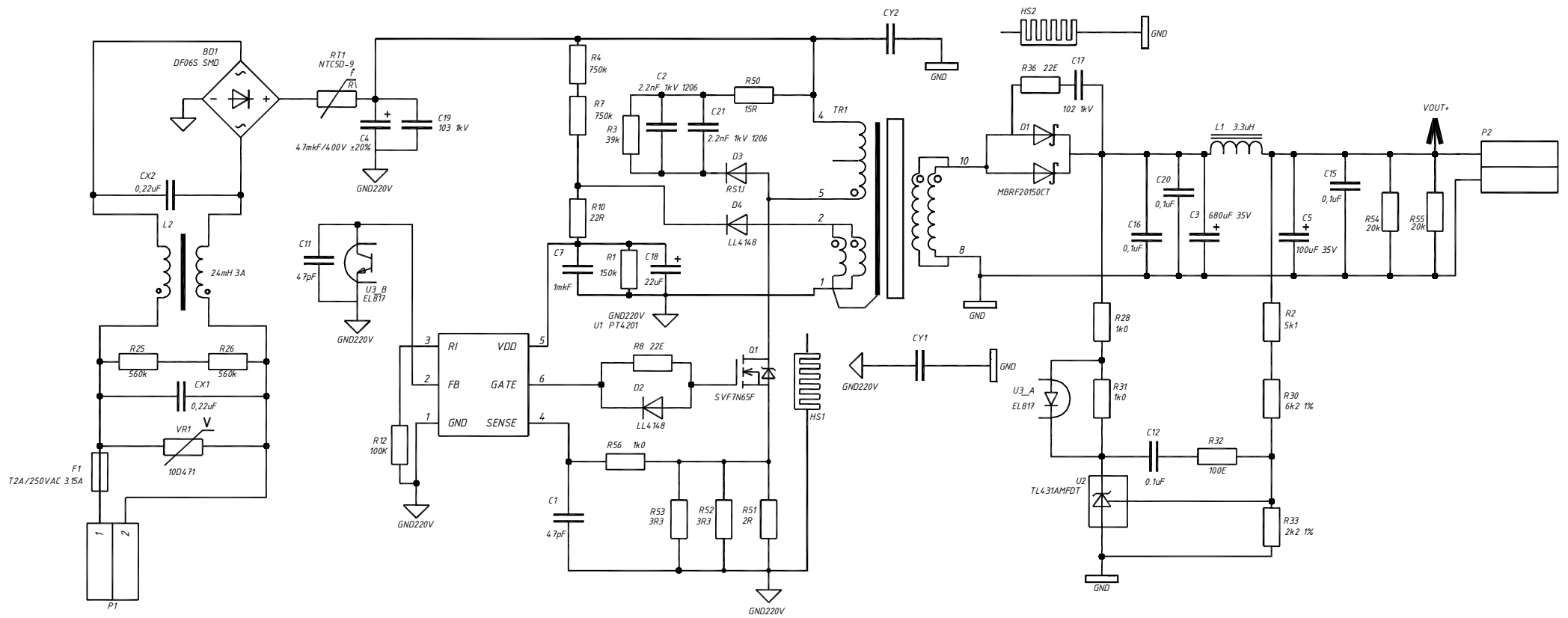

Модуль питания PM15VDC-20
 Схема электрическая принципиальная

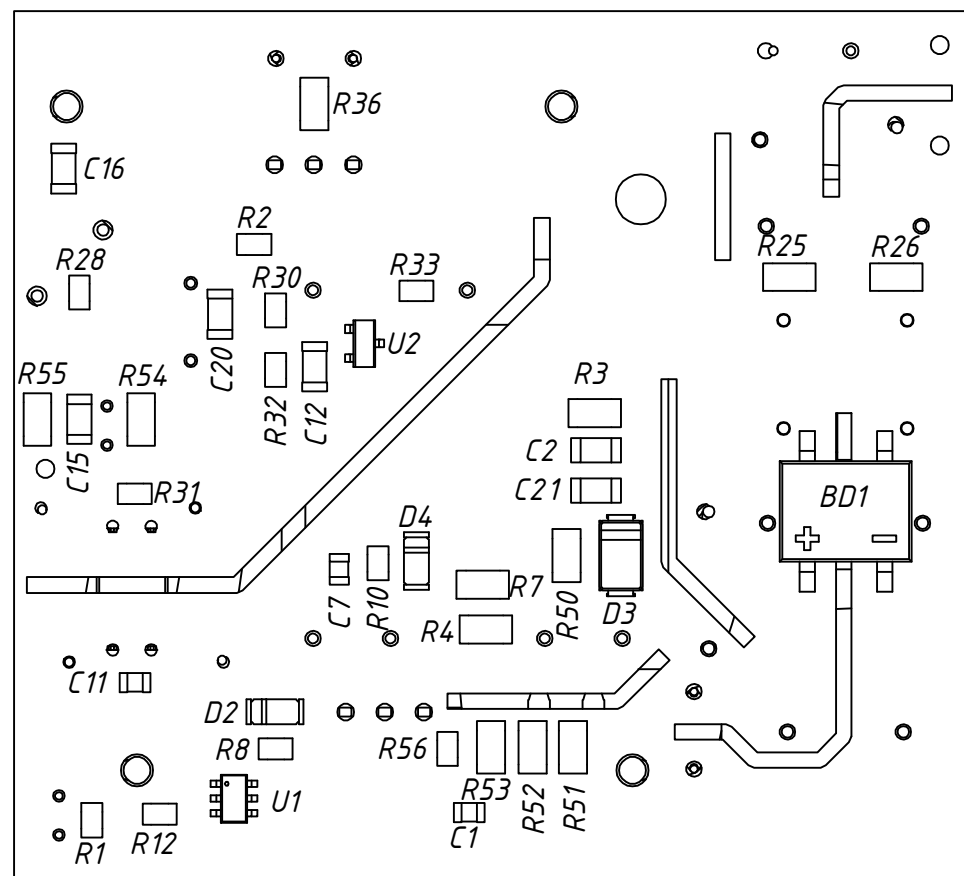
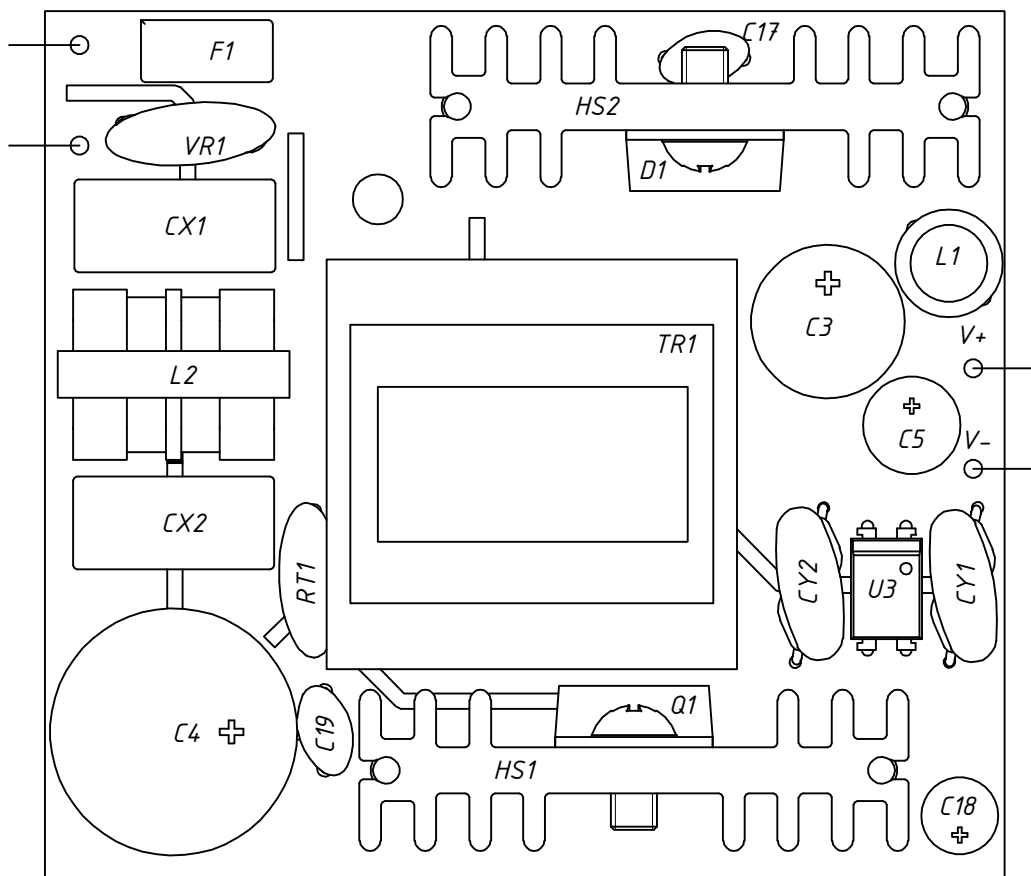

Плата модуля питания PM15VDC-20
Сборочный чертеж